

# EX2600



## HYDRAULIC EXCAVATOR

<b>Model Code:</b>	EX2600-7 (Fuel Consumption Optimization)	<b>Model Code:</b>	EX2600-7B (Tier 4 Final)	<b>Model Code:</b>	EX2600-7E
<b>Engine Rated Power:</b>	Cummins: 1 119 kW (1 520 PS, 1 500 HP) MTU: 1 150 kW (1 563 PS, 1 542 HP)	<b>Engine Rated Power:</b>	Cummins: 1 119 kW (1 520 PS, 1 500 HP) MTU: 1 150 kW (1 563 PS, 1 542 HP)	<b>Power Output:</b>	860 kW (1 169 PS, 1 153 HP)
<b>Operating Weight:</b>	Cummins Loading Shovel: 258 000 kg (568,793 lb.) Backhoe: 256 000 kg (564,383 lb.) MTU Loading Shovel: 260 000 kg (573,202 lb.) Backhoe: 258 000 kg (568,793 lb.)	<b>Operating Weight:</b>	Cummins Loading Shovel: 259 000 kg (570,997 lb.) Backhoe: 257 000 kg (566,588 lb.) MTU Loading Shovel: 261 000 kg (575,407 lb.) Backhoe: 259 000 kg (570,997 lb.)	<b>Bucket:</b>	Loading Shovel: ISO Heaped : 15.0 - 16.5 m <sup>3</sup> (19.6 - 21.6 cu. yd.) Backhoe: ISO Heaped : 17.0 - 19.5 m <sup>3</sup> (22.2 - 25.5 cu. yd.)
<b>Bucket:</b>	Loading Shovel: ISO Heaped : 15.0 - 16.5 m <sup>3</sup> (19.6 - 21.6 cu. yd.) Backhoe: ISO Heaped : 17.0 - 19.5 m <sup>3</sup> (22.2 - 25.5 cu. yd.)	<b>Bucket:</b>	Loading Shovel: ISO Heaped : 15.0 - 16.5 m <sup>3</sup> (19.6 - 21.6 cu. yd.) Backhoe: ISO Heaped : 17.0 - 19.5 m <sup>3</sup> (22.2 - 25.5 cu. yd.)		



*Introducing the*  
**NEW EX2600-7**

With more than 100 years of industry experience from group companies, Hitachi continues to balance leading innovation with established, dependable design. The EX-7 series showcases this balance, placing Hitachi excavators in a class of their own.

Agile enough to handle any terrain yet powerful enough to maximize productivity, the EX2600-7 is a machine without compromise.

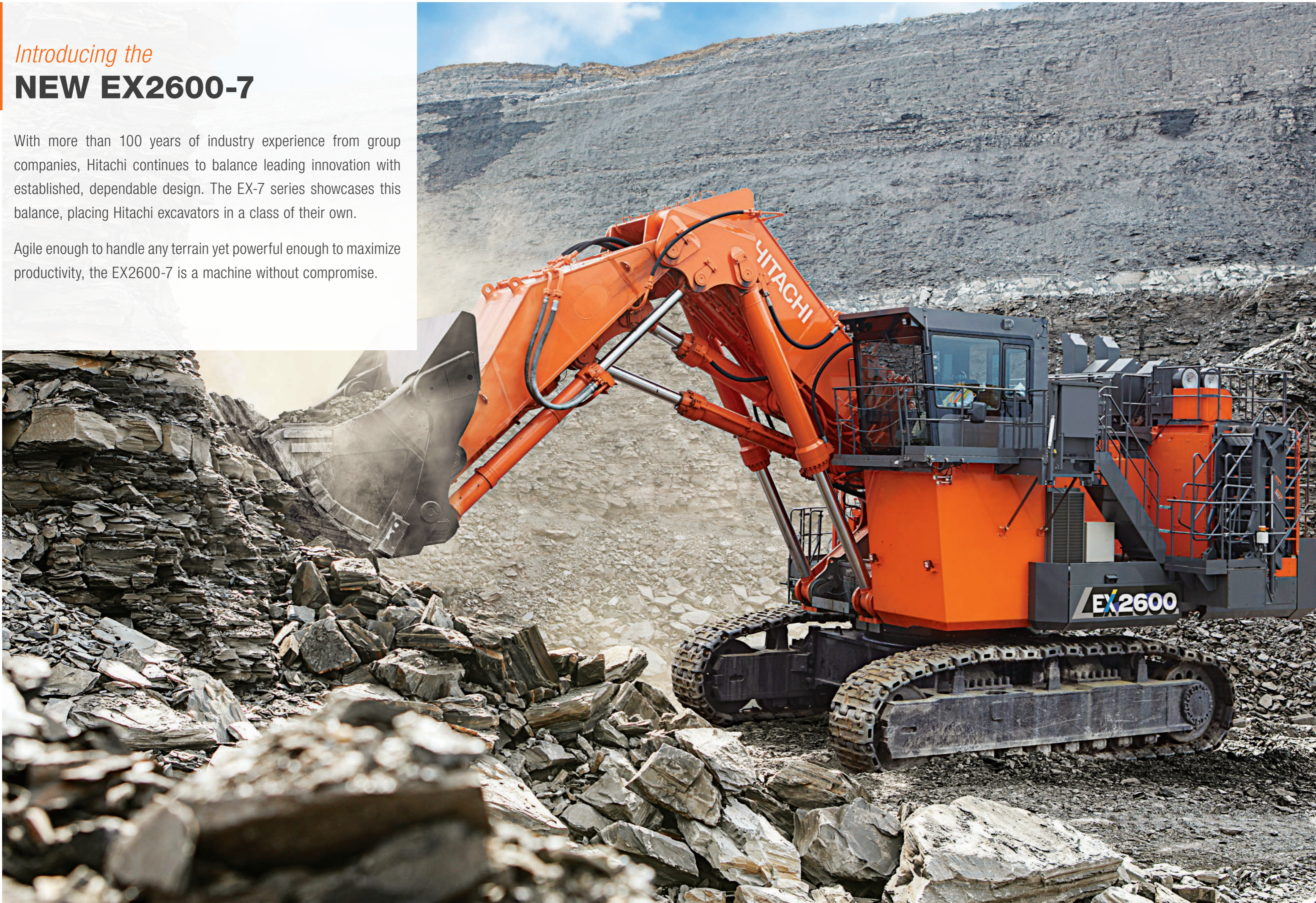



# designed for SUSTAINABILITY

Hitachi's latest energy optimization features are delivering a greener future for the mining industry. A selection of engine models including a choice of emission configurations to meet regulatory requirements, electronically controlled hydraulic pumps, optimized cooling package, and enhanced hydraulic circuits deliver unparalleled performance with environmental conscience.

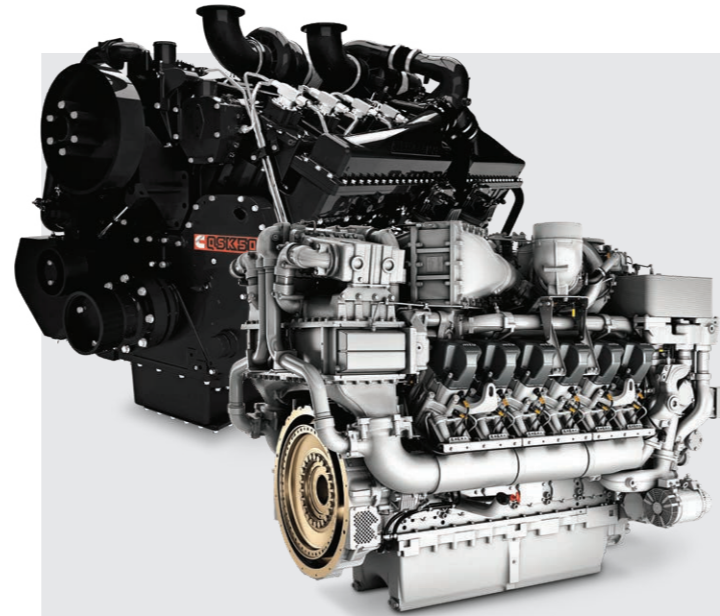

## ENGINE OPTIONS

### CUMMINS

Cummins QSK50, 16 cylinder, 50.0 L (3,051cu.in.), turbo-charged, after-cooled 1 119 kW (1 520 PS, 1 500 HP)

#### Options:

Cummins diesel engine U.S.A. E.P.A. Tier 4 conforming model, with Diesel Exhaust Fluid (DEF) tank

Cummins diesel engine Fuel Consumption Optimization (FCO) model

### MTU

MTU 12V4000, 12 cylinder, 57.2 L (3,490cu.in.), turbo-charged, after-cooled 1 150 kW (1 563 PS, 1 542 HP)

#### Options:

MTU diesel engine U.S.A. E.P.A. Tier 4 conforming 2-stage turbo-charged model

MTU diesel engine Fuel Consumption Optimization (FCO) single stage turbo-charged model

### HITACHI AC ELECTRIC MOTOR

The EX2600-7E electric excavator is available, operating with the Hitachi AC electric motor

#### Options:

electric motor (860 kW, 1 169 PS, 1 153 HP) 50 Hz, 6 000 V, 6 600 V\*

electric motor (860 kW, 1 169 PS, 1 153 HP) 60 Hz, 6 600 V, 6 900 V\*

\*Please contact hitachi for other specification request



## MAIN PUMP ELECTRIC REGULATORS

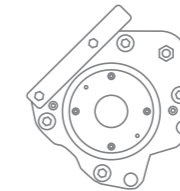

Each individually controlled hydraulic pump has its own electric regulator, enhancing engine power, lowering fuel consumption, and increasing productivity to lower the total cost of operation.

## HYDRAULIC REGENERATION CIRCUIT

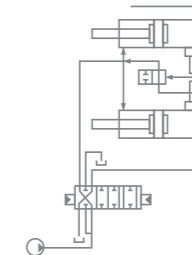

The flow regeneration valve fitted to the hydraulic system reduces pump demand, ultimately reducing power requirements from the hydraulic system and engine. The result is lower fuel consumption and improved pump life.

## HYDRAULIC OIL COOLER

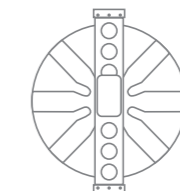

A larger hydraulic oil cooler with variable speed fan reduces energy demand and creates a more reliable hydraulic system. The oil cooler is kept separate from the radiator to reduce hydraulic oil temperatures, increase hydraulic service life, and improve maintainability.

## RADIATOR FAN CLUTCH



The radiator fan clutch and variable speed fan are specifically tailored to engine cooling requirements, resulting in an optimized cooling system with less engine horsepower demand and less operational noise.



*designed for*  
**PRODUCTIVITY**

Mining is a very demanding industry, which is why Hitachi's EX-7 excavators go above and beyond project requirements to deliver maximum performance.

The EX2600-7 is packed with efficient features to meet any challenge.

**FRONT ATTACHMENT**

With a front attachment design that prioritizes performance, the EX2600-7 can achieve superior productivity under different digging profiles.

The boom and arm are strategically welded, utilizing a full-box section design to evenly distribute stress and provide ease of maintenance.

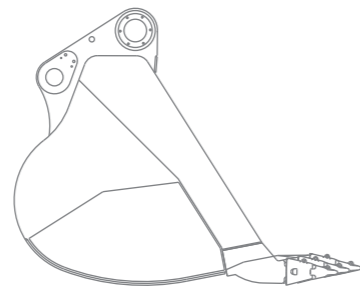
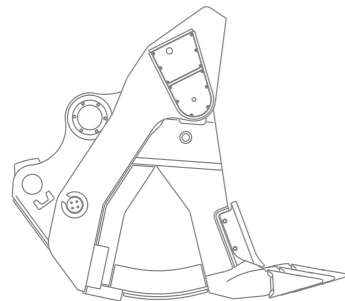

**LOADING SHOVEL**

The Loading Shovel attachment is equipped with an auto-leveling crowd mechanism that controls the bucket at a constant angle. The bucket has been designed to enhance loading capability with a tilt angle that enhances operational efficiency.

**LOADING SHOVEL EXCAVATING FORCE**

**Arm crowding force on ground**  
 918 kN (93,600 kgf, 206,375 lbf.)

**Bucket digging force**  
 943 kN (96,200 kgf, 211,995 lbf.)

**BACKHOE**

The Backhoe attachment is designed using computer aided box frame analysis to determine the optimal structure for integrity and longevity. Complete with floating pin and bush, the bucket has been designed to match the geometry of the attachment to maximize productivity.

**BACKHOE EXCAVATING FORCE**

**Arm crowding force**  
 785 kN (80,000 kgf, 176,475 lbf.)

**Bucket digging force**  
 830 kN (84,600 kgf, 186,591 lbf.)





## designed for **SAFETY**

Hitachi prioritizes safety, and the EX-7 excavators are safer to operate and maintain than ever before. The EX2600-7 includes dependable safety features like an on-board inclinometer, improved walkways, handrails, and dual isolator switch as standard, delivering absolute protection.

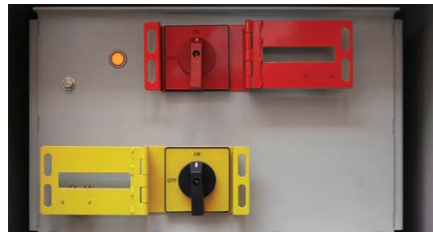

### DUAL ISOLATOR SWITCH

The conveniently located dual isolator switch offers the option to deactivate the engine and battery individually. When inspections and maintenance are required, the battery isolator provides the benefit of isolating both the positive and negative terminals of the battery for a safe working environment. The engine isolator deactivates the engine starter motor while allowing battery power to the electric system for troubleshooting, to enhance safety and maintainability.



### ON-BOARD INCLINOMETER

The on-board inclinometer assists the operator to work within the safe limits of the machine, with two predetermined safety limits providing extra assurance. If the first safety limit is exceeded, the operator receives a visual alert prompting them to take corrective action. The alert escalates to an audible alarm if the second safety limit is breached.

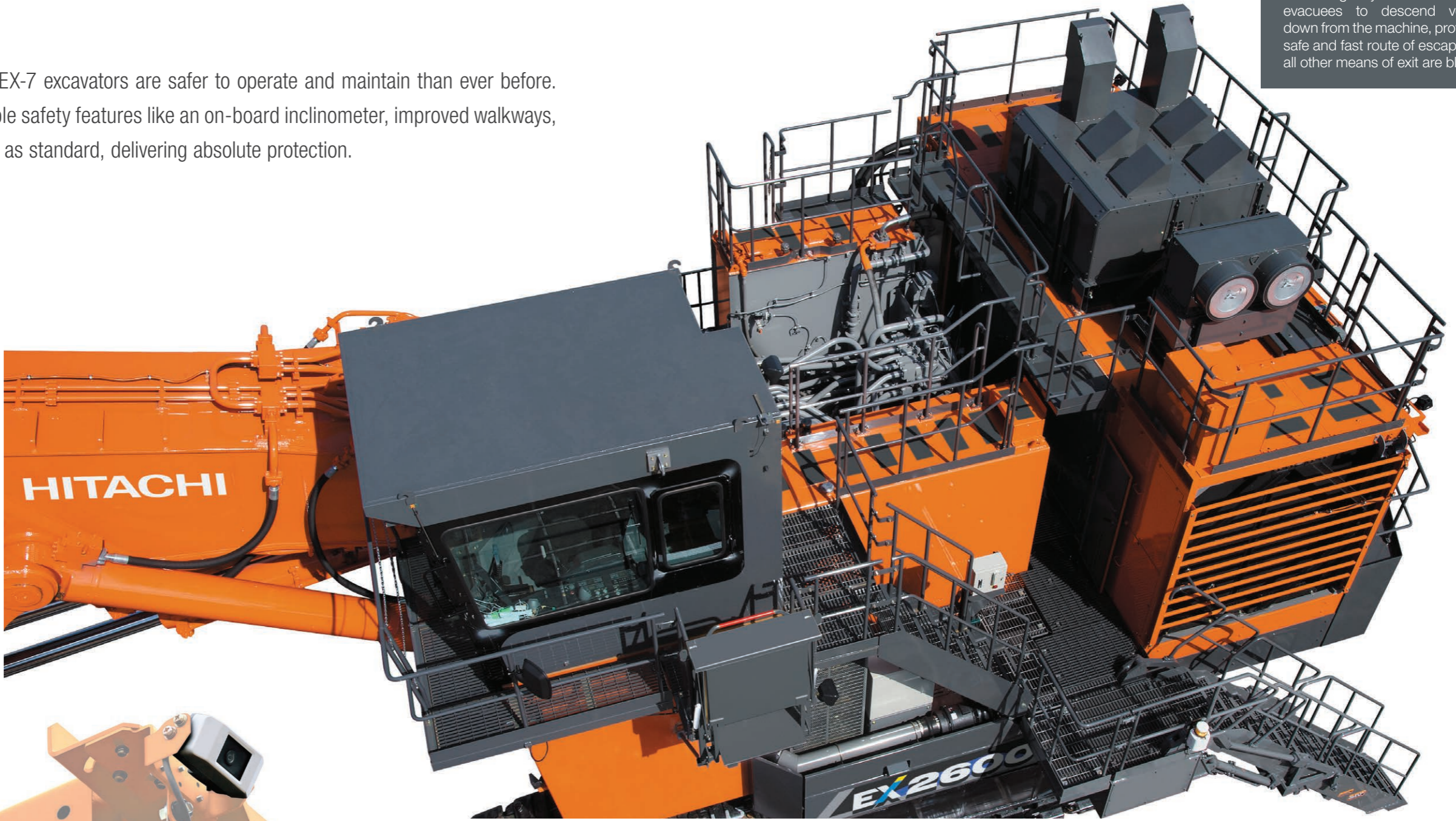

### EMERGENCY ESCAPE CHUTE

An escape chute has been added to the side of the cab for use in an emergency. The chute allows evacuees to descend vertically down from the machine, providing a safe and fast route of escape when all other means of exit are blocked.

### PERIMETER MONITORING CAMERAS (OPTIONAL)

Optional perimeter monitoring cameras offer better visibility of a surrounding area, reducing blind spots for the operator. Two cameras are located at both the front and rear of the excavator, and are linked to monitors inside the cab.

### ENGINE STOP SWITCHES

Engine stop switches are located in easily accessible areas: two in the engine room, two in the pump room, and one emergency stop switch in the cab.

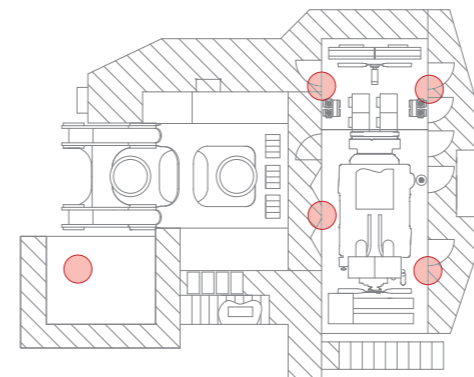

### ACCESS AND WALKWAYS

Anti-slip walkways and specially designed handrails reduce the risk of tripping when maneuvering around the machine, and provide ease of access for operators and maintenance personnel.

Wide, low-gradient, non-slip, hydraulic folding stairs allow for easy and safe access to the machine.





### MULTI-FUNCTIONAL DISPLAY

Fitted with an LED back-light to improve clarity and reduce glare, the multi-functional display provides key machine information, performance indicators and through use of an integrated dial switch interface.



## designed for OPERATOR COMFORT

A comfortable operating environment is essential for productivity, and the EX2600-7 is engineered for a luxurious operator experience. Features like ergonomic layout, electronic joysticks, intelligent Multi-Functional Display, advanced air suspension seating and better climate control boost operator productivity.

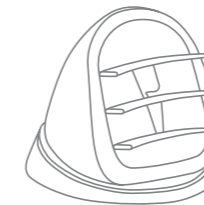

### CLIMATE CONTROLLED AIR CONDITIONING

The pressurized cab's climate controlled air conditioning helps to overcome environmental extremes. Optimized filtering of interior and exterior air combined with the new flexi-vent system provides a personalized and balanced environment that meets operator demands.



### OPERATOR SEAT

Specifically designed for use in the mining industry, the automatic weight-adjusting air suspension seat calculates optimal cushioning to match the operator's weight, enhancing comfort and minimizing vibration.



### ELECTRONIC JOYSTICKS

Integrated electronic joysticks connected to the machine's microprocessor enable precise and almost effortless operation, minimizing operator fatigue and improving operational performance.



### ROLL SCREENS

Retractable front and side roll screens protect the operator from UV glare and reduce heat buildup in the cab, improving the efficiency of the climate controlled air conditioner for a superior operating environment.

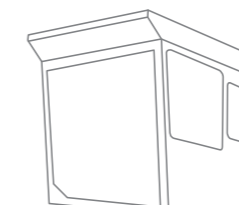

### OPERATOR CABIN

The use of laminated tinted windows reduce heat and glare. Sound-suppression further enhances ergonomics and comfort for the operator.

The Level II Operator Protective Guard (OPG) provides secure protection from falling objects, ensuring operator safety.





*designed for*  
**EASE OF  
 MAINTENANCE**

Hitachi's EX-7 series of excavators are designed to streamline and safeguard maintenance for a more intuitive and operator-friendly machine. A modular arrangement offers spacious passageways and work platforms to simplify daily upkeep and major component inspections, and makes the EX2600-7 easy and safe to maintain.

**AUTO-LUBRICATION SYSTEM**

A new auto-lubrication system comes with 380 L (100.4 gal.) large capacity grease tank, new grease pump, in-line grease filter with breather, grease level indicator in cab and provision for fitment of a second grease pump in the lubrication tank. These features provide a more reliable system with less downtime.

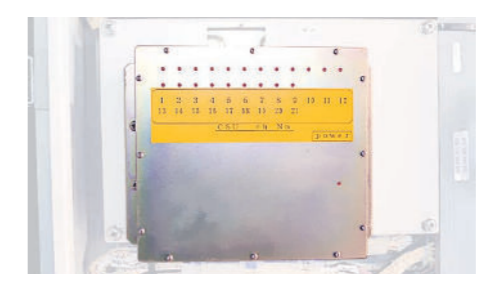
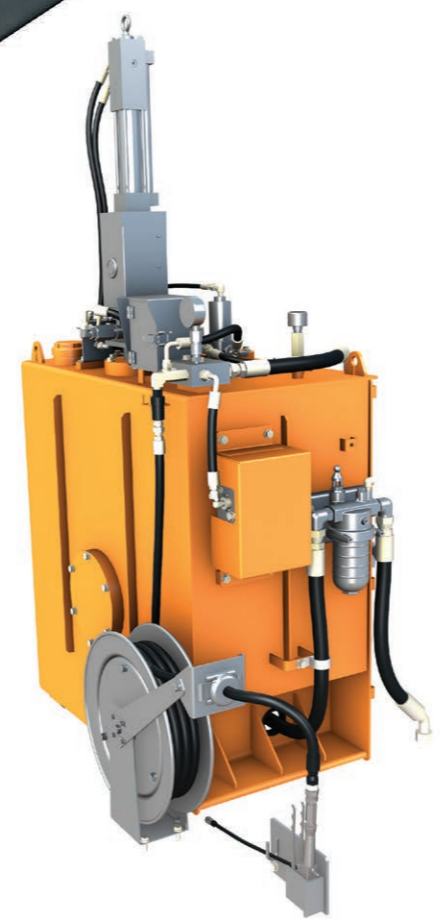

**CONTAMINATION SENSORS**

Contamination sensors are located on main hydraulic pumps, travel motor and swing motor to detect any contaminants that may cause damage to the hydraulic system. Sensors alert the operator of potential contaminants and record the fault code in the Data Logging Unit (DLU), with the capability to remotely advise maintenance personnel.



**CENTRALIZED LUBRICATION SYSTEM**

The centralized fast-filling system provides easy access from the ground to refill and evacuate lubricants, water, grease and fuel. The fast-filling system can be fitted with an optional quick coupler.



**GREASE-LESS CENTER JOINT**

The new center joint uses the machine's hydraulic oil to self-lubricate, reducing the need for daily maintenance.



**LUBRICATION PIPING COVER**

A swing circle cover has been added to the outside of the swing bearing, protecting the lubrication piping from debris damage.





*designed for*  
**DURABILITY**

A machine is only as productive as its lifespan, which is why Hitachi's EX-7 excavators are built to last in the toughest of conditions. Advanced computer modelling, specialized forgings, and pedestal design track shoes are just some of the features that give the EX2600-7 unmatched endurance and exceptional productivity.

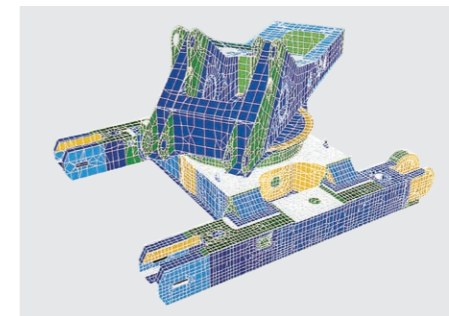

**RIGID BOX DESIGN**

Computer assisted analysis has been used to determine the most effective design for frame longevity, ensuring the EX2600-7 withstands the demands of any mining operation.



**CENTER TRACK FRAME**

Hitachi's exclusive center track frame delivers optimal stress dispersion, through the use of specially designed forged steel parts, to reduce the chance of failure in critical high-stress areas. This guarantees a stronger frame with improved durability.

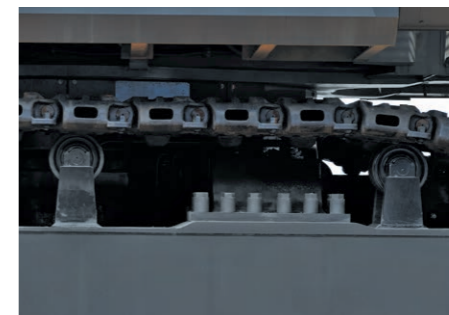

**UPPER ROLLERS**

The EX2600-7 undercarriage has three double-sided, pedestal-designed upper rollers on each side of the track frame. These rollers maintain track shoe clearance and provide protection from debris buildup, reducing shoe and roller wear for a more reliable undercarriage system.



**OIL-FILLED ROLLERS & IDLERS**

The oil-filled idlers and upper and lower rollers eliminate the need for daily lubrication, helping reduce maintenance costs.



**TRACK SHOES**

Hitachi's classic track shoe design has been applied to mitigate premature wear of the drive-lugs. Each shoe is induction hardened using Hitachi's proven methods to deliver a superior and more durable solution.



**CENTER FRAME UNDERGUARD (OPTIONAL)**

A newly designed heavy duty guard protects hoses and accumulators located in the track center frame from rocks and debris ingress, providing extra protection and reliability.



## ELECTRONIC CYLINDER STROKE CONTROL

The new on-board electronic controller receives signals from angle sensors fitted to the main frame, boom and arm to control the pump flow rate and cylinder speed. Shock at stroke end of the cylinder cycle is reduced, improving operator comfort and lowering impact on cylinders and structures for more reliable operation.



## designed for **RELIABILITY**

Hitachi's longstanding commitment to engineering and design excellence makes EX-7 excavators the most reliable on the market. The EX2600-7 integrates advanced technologies with trusted durable design for a consistently dependable machine.



### FRONT ATTACHMENT HOSES

Hitachi's hose design has been tested on a high cyclic fatigue rate to maximize longevity and improve safety. Front attachment hoses have been rearranged from the traditional arch style to an underslung configuration removing the need for clamping, reducing chafing and increasing reliability.

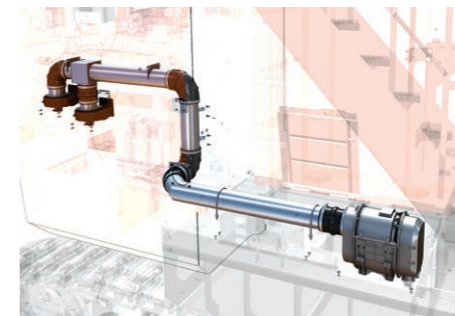

### CAB RISER PRESSURIZER

The cab riser now features a pressurizer system to reduce dust infiltration, extending service life of the electronic components and devices within.

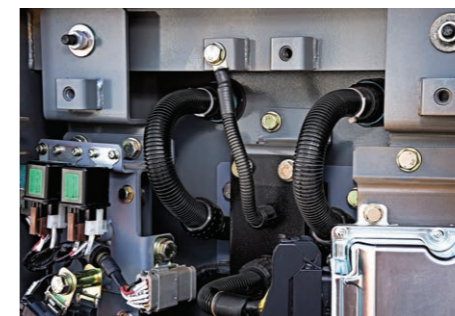

### SOLID CONDUIT WIRE HARNESES

Newly introduced solid conduit harnesses and junction boxes prevent dust and moisture ingress, improving longevity. Electrical harnesses between junction boxes can be replaced individually, reducing maintenance time and cost.



### OPERATING LIGHTS

Strategically placed long-life LED working lights provide assured reliability for night operations.



*designed for*  
**INTELLIGENCE**

Hitachi's EX-7 excavators connect physical features with digital technologies for seamless and intuitive operation. Extensive onboard sensors, diagnostic tools, real time data and advanced software allow the EX2600-7 to empower personnel with a better understanding of mining operations.

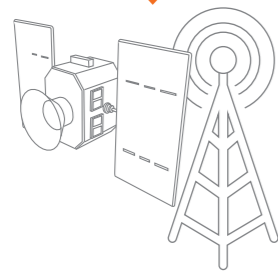

ANTENNA (GPRS) OR SATELLITE

**SATELLITE / GPRS COMMUNICATION (OPTIONAL)**

Standard machine information is transmitted daily through either satellite or GPRS (General Packet Radio Service) communication, sending data directly to the Hitachi Global e-Service platform to support the mining operation.

**Globale-Service**

Global e-Service is a Hitachi web-based platform that sends vital machine information directly to the customer in an easy-to-understand format.

**WIRELESS INTERFACE (OPTIONAL)**

Detailed machine information can be remotely downloaded from the Data Logging Unit (DLU) via the Wireless Interface Unit (WIU), providing vital operational & performance data.



ON-SITE STAFF



INFORMATION CENTER, HITACHI CONSTRUCTION MACHINERY



CUSTOMER



HITACHI CONSTRUCTION MACHINERY GROUP AND DEALERS

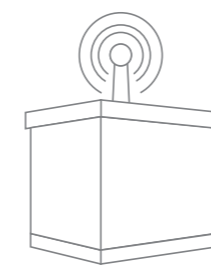

FLEET MANAGEMENT SYSTEM



The DLU can be combined with Wenco or another third party fleet management system to provide live operational and performance information, assisting with fleet management.

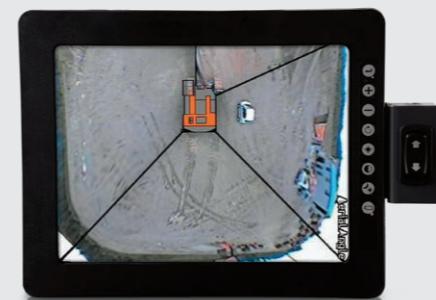

**Aerial Angle (OPTIONAL)**

Aerial Angle provides the operator with a real-time continuous birds-eye view around their excavator. Cameras strategically mounted on the machine combine to a single aerial view of the EX2600-7 surroundings. Multiple screen display options can be selected on the cab's 12-inch Aerial Angle monitor for ease of operation.



# SPECIFICATIONS

## WORKING RANGES

### Loading Shovel

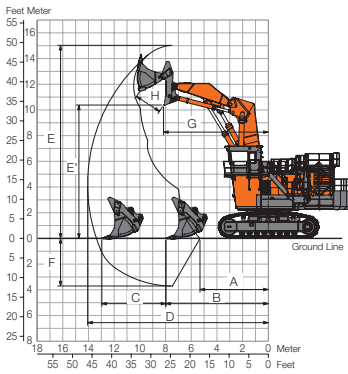

A:	Minimum Digging Distance	5 340 mm (17 ft. 6 in.)
B:	Minimum Level Crowding Distance	7 980 mm (26 ft. 2 in.)
C:	Level Crowding Distance	4 980 mm (16 ft. 4 in.)
D:	Maximum Digging Reach	14 060 mm (46 ft. 2 in.)
E:	Maximum Cutting Height	15 010 mm (49 ft. 3 in.)
E':	Maximum Dumping Height	10 350 mm (34 ft.)
F:	Maximum Digging Depth	3 720 mm (12 ft. 3 in.)
	Working Radius at Maximum Dumping Height	8 140 mm (26 ft. 9 in.)
H:	Maximum Bucket Opening Width	2 150 mm (7 ft. 1 in.)

### Backhoe

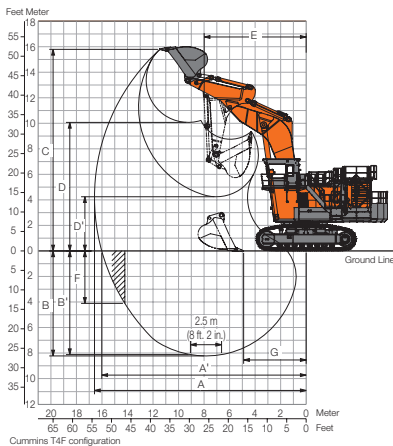

A:	Maximum Digging Reach	16 600 mm (54 ft. 6 in.)
A':	Maximum Digging Reach (on ground)	16 050 mm (52 ft. 8 in.)
B:	Maximum Digging Depth	8 250 mm (27 ft. 1 in.)
	Maximum Digging Depth (2.5 m (8 ft. 2 in.) level)	8 150 mm (26 ft. 9 in.)
C:	Maximum Cutting Height	15 800 mm (51 ft. 10 in.)
D:	Maximum Dumping Height	10 100 mm (33 ft. 2 in.)
D':	Minimum Dumping Height	4 250 mm (13 ft. 11 in.)
E:	Minimum Swing Radius	7 990 mm (26 ft. 3 in.)
F:	Maximum Vertical Wall	4 110 mm (13 ft. 6 in.)
G:	Minimum Level Crowding Distance	4 900 mm (16 ft. 1 in.)

## UPPER STRUCTURE

Swing speed	4.1 min <sup>-1</sup> (rpm)
Fuel tank capacity	5 300 L (1,400 gal.)
DEF tank capacity (T4F only)	356 L (94 gal.)

## HYDRAULIC SYSTEM

Main Pumps	6 variable-displacement, axial piston pumps for front attachment, travel and swing
Pressure setting	29.4 MPa (300 kgf/cm <sup>2</sup> , 4,264 psi)
Max. oil flow	4 x 375 L/min (4 x 99.1 gal./min.), 2 x 425 L/min (2 x 112.3 gal./min.)

## UNDERCARRIAGE

Travel speeds	High : 0 to 2.3 km/h (0 to 1.4 mph) Low : 0 to 1.6 km/h (0 to 1.0 mph)
Maximum traction force	1 330 kN (135 600 kgf, 298,944 lbf.)

## WEIGHTS AND GROUND PRESSURE

### Loading Shovel

Equipped with 15.0 m<sup>3</sup> (19.6 cu. yd.) (ISO heaped) bottom dump bucket

Shoe width	Weight	Ground pressure
1 000 mm (40 in.)	259 000 kg (570,997 lb.)	189 kPa (1.92 kgf/cm <sup>2</sup> , 27.4 psi)

### Backhoe

Equipped with 17.0 m<sup>3</sup> (22.2 cu. yd.) (ISO heaped) bucket

Shoe width	Weight	Ground pressure
1 000 mm (40 in.)	257 000 kg (566,588 lb.)	187 kPa (1.91 kgf/cm <sup>2</sup> , 27.1 psi)

Cummins T4F configuration

## ATTACHMENTS

### Loading Shovel

#### Bucket Capacity (ISO heaped)

15.0 m<sup>3</sup> (19.6 cu.yd.) : Material density 1 800 kg/m<sup>3</sup> (3,034 lb./cu.yd.) or less  
16.5 m<sup>3</sup> (21.6 cu.yd.) : Material density 1 600 kg/m<sup>3</sup> (2,697 lb./cu.yd.) or less

### Backhoe

#### Bucket Capacity (ISO heaped)

17.0 m<sup>3</sup> (22.2 cu.yd.) : Material density 1 800 kg/m<sup>3</sup> (3,034 lb./cu.yd.) or less  
18.0 m<sup>3</sup> (23.5 cu.yd.) : Material density 1 800 kg/m<sup>3</sup> (3,034 lb./cu.yd.) or less  
19.5 m<sup>3</sup> (25.5 cu.yd.) : Material density 1 600 kg/m<sup>3</sup> (2,697 lb./cu.yd.) or less

## ENGINE

Model	Cummins QSKTA50 -CE (FCO,T4F)
Rated power @1 800 min <sup>-1</sup> (rpm)	ISO14396 : 1 119 kW (1 520 PS, 1 500 HP)
Piston displacement	50.0 L (3,051 cu.in.)
Model	MTU 12V4000 C33R (FCO)
Rated power @1 800 min <sup>-1</sup> (rpm)	ISO14396 : 1 150 kW (1 563 PS, 1 542 HP)
Piston displacement	57.2 L (3,490 cu.in.)
Model	MTU 12V4000 C15 (T4F)
Rated power @1 800 min <sup>-1</sup> (rpm)	ISO14396 : 1 150 kW (1 563 PS, 1 542 HP)
Piston displacement	57.2 L (3,490 cu.in.)

## DIMENSIONS

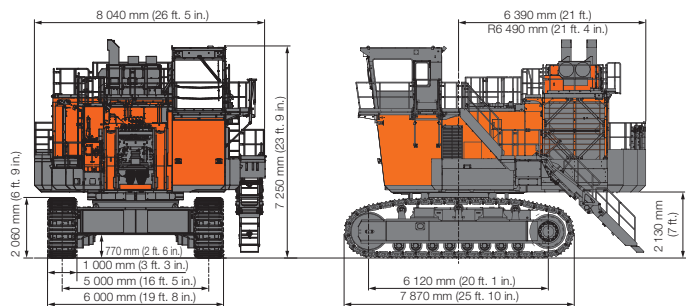

## PASS MATCH

Best match: 4-6 passes

Potential match: 3-8 passes

Model	60t class truck	100t class truck	EH3500AC-3	EH4000AC-3
EX2000-7	BH 12.0 m <sup>3</sup> (15.7 cu.yd.)	3	5	
	LD 12.0 m <sup>3</sup> (15.7 cu.yd.)	3	5	
EX2600-7	BH 17.0 m <sup>3</sup> (22.2 cu.yd.)		3	6
	LD 15.0 m <sup>3</sup> (19.6 cu.yd.)		4	8
EX3600-7	BH 22.0 m <sup>3</sup> (28.8 cu.yd.)		3	5
	LD 22.0 m <sup>3</sup> (28.8 cu.yd.)		3	5

## ENVIRONMENT

Auto control air conditioner contains fluorinated greenhouse gases ,  
Refrigerant type: HFC-134a, GWP: 1430, Amount: 2.80 kg (6.17 lb.), CO2e:  
4.00 tonnes (4.41 tons).

These specifications are subject to change without notice. Illustrations and photos show the standard models, and may or may not include optional equipment, accessories, and all standard equipment with some differences in color and features. Before use, read and understand the Operator's Manual for proper operation.